



Healthy Drinking
Water for Life

The Aquasana Drinking Water Enhancement System

Ultra high quality drinking water at the convenience of tap water for only 9 cents a gallon!**

This product represents a new era in home water treatment. Independent laboratory tests have documented this system's ability to reduce contaminants more effectively and economically than other home water systems. (See product comparison chart in "Support Info" section.)

Contaminant reduction claims have been evaluated and certified by the California Department of Health Services for accuracy. (see CA Certificate)

Aquasana's twin cartridge, multi-stage filtration process uses a combination of the most effective technologies available, mechanical filtration, adsorption and ion exchange.

This patented process selectively filters out specific contaminants while allowing the natural minerals to remain, creating the healthiest, best tasting water possible.

The "A" cartridge... filters out sediment and turbidity first, tiny microscopic particles that can cause cloudiness and unpleasant taste and odor in water.

The "A" cartridge also filters out chlorine, the most concentrated and the most competitive chemical in our water. This allows the following stages in cartridge "B" to focus on the more difficult contaminants like lead and synthetic chemicals.

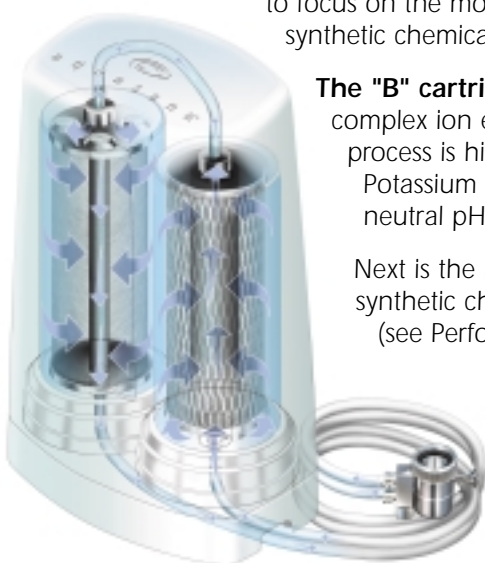

The "B" cartridge... is where the final stages of filtration take place. Lead is filtered out by a complex ion exchange process where lead ions are replaced with potassium ions. This process is highly effective and also enhances the natural mineral balance of water.

Potassium is one of the minerals that gives water a natural spring water taste and a neutral pH.

Next is the most challenging and possibly the most important stage, the adsorption of synthetic chemicals, like herbicides, pesticides and industrial solvents, (see Performance Data Sheet in Support Info section for specific performance claims).

The "B" cartridge is also a 0.5 micron mechanical filter effective for chlorine resistant microscopic organisms like cryptosporidium and giardia, two common water borne parasites that can cause flu like symptoms for most, but can also be fatal to small children and the elderly.

Filter cartridges last for 500 gallons and should be replaced every 6 months.

The result is a refreshing, great tasting, healthy supply of drinking water at the convenience of your own kitchen faucet for only 9 cents a gallon.

(A&B filter cartridges are included and last for 500 gallons/ 6 months.)

AQ-4000 Counter-top Filtration System Factory Direct list price \$119.95

AQ-4125 Replacement cartridge set (A&B) Factory Direct list price \$56.25

**A & B replacement cartridge set price is \$45.00 with FREE shipping on the Water 4 Life auto-ship program. (See "Water 4 Life Program" in the Support Info section)

The AQ-4000 system can also be installed under the counter with the AQ-40 Under-sink conversion kit. (See "Products" section)

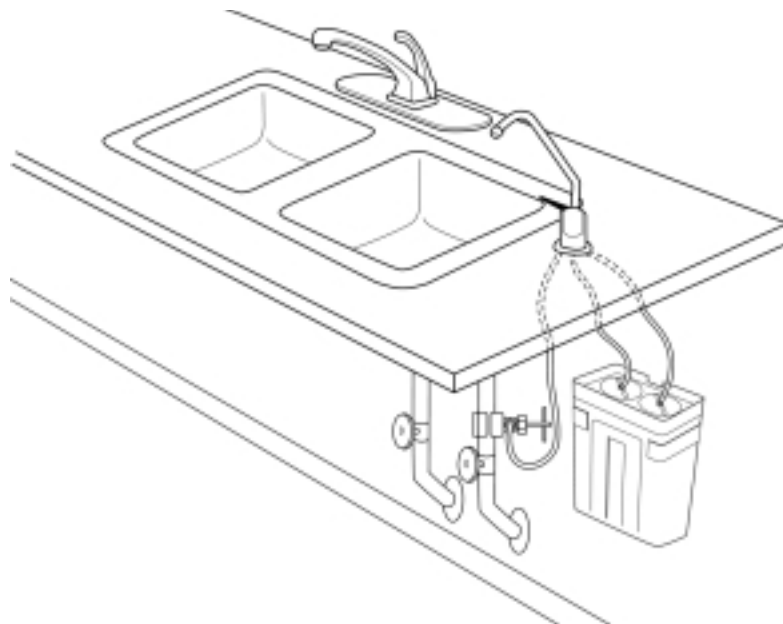

AQ-40 Under-Sink Conversion Kit Factory Direct List Price \$49.95

All Aquasana products are covered by our "100% Pure Satisfaction Guarantee"

If your not 100% satisfied with your purchase... we'll buy it back from you, it's that simple!

See Aquasana's "Pure Satisfaction Guarantee" in the Product Support section.

To make a purchase, close this window and go to the "Products" section.